

LEFTHAND OPERATOR

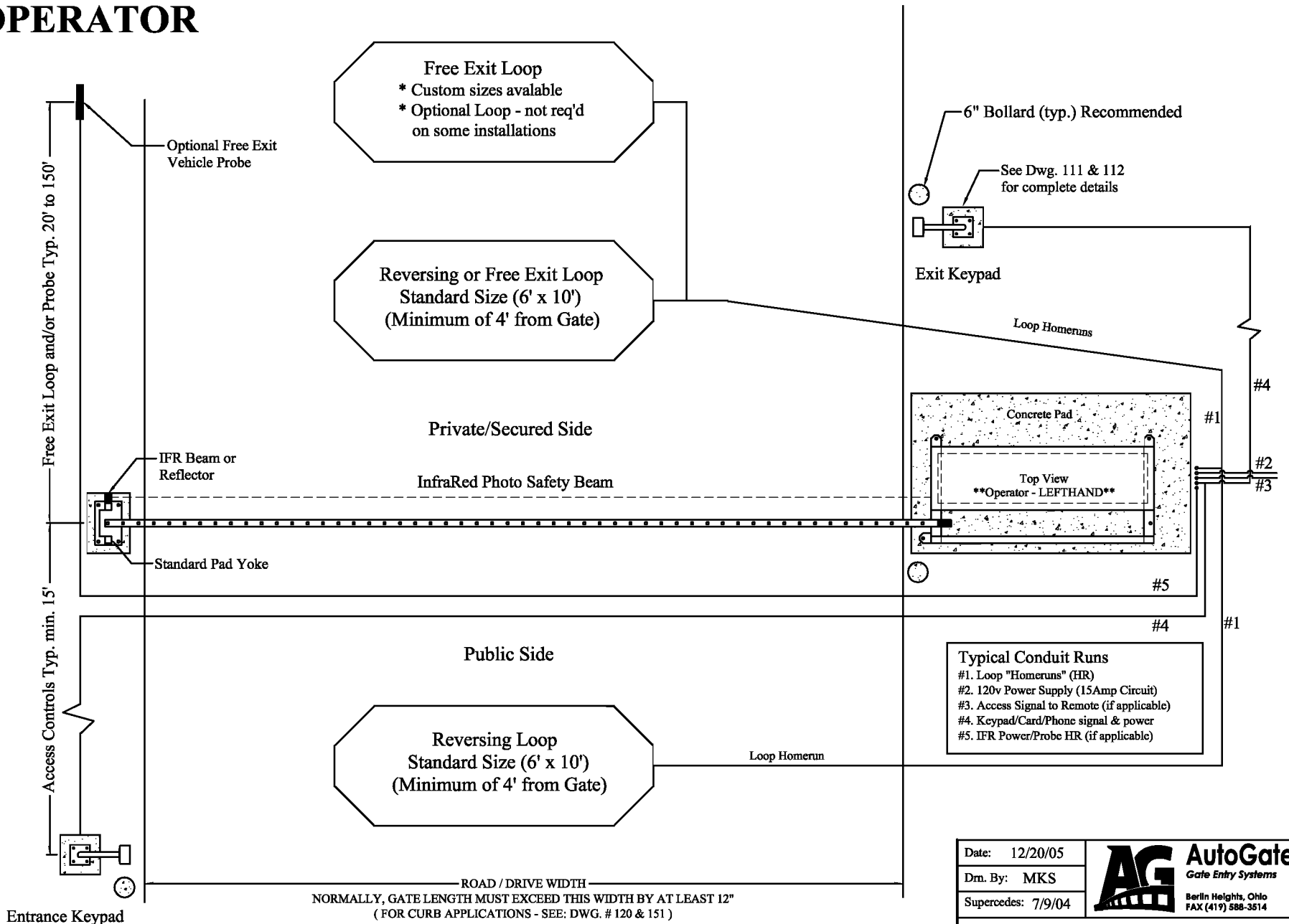

Printed: 04/06/07

Date:	12/20/05	AG AutoGate Gate Entry Systems
Drn. By:	MKS	
Supercedes:	7/9/04	Berlin Heights, Ohio FAX (419) 588-3514
Dwg.:	100-L	
Title: Operator and Accessory Site Layout		

LEFTHAND OPERATOR

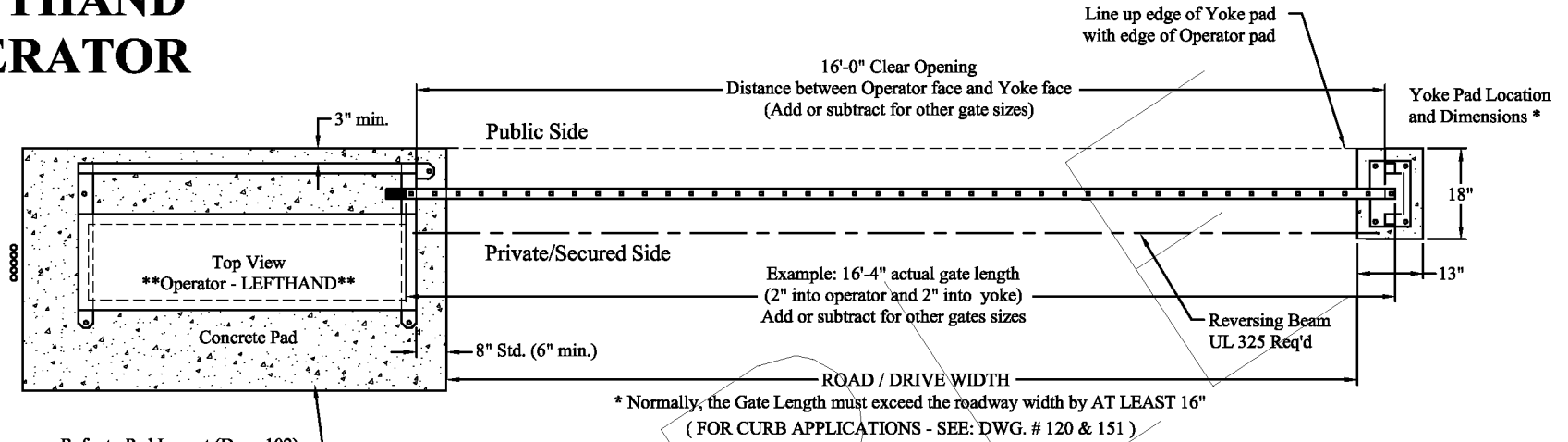

Refer to Pad Layout (Dwg. 102)
for more details and instructions

Example Shown: 16' x 5' Buckeye Style 500 Gate

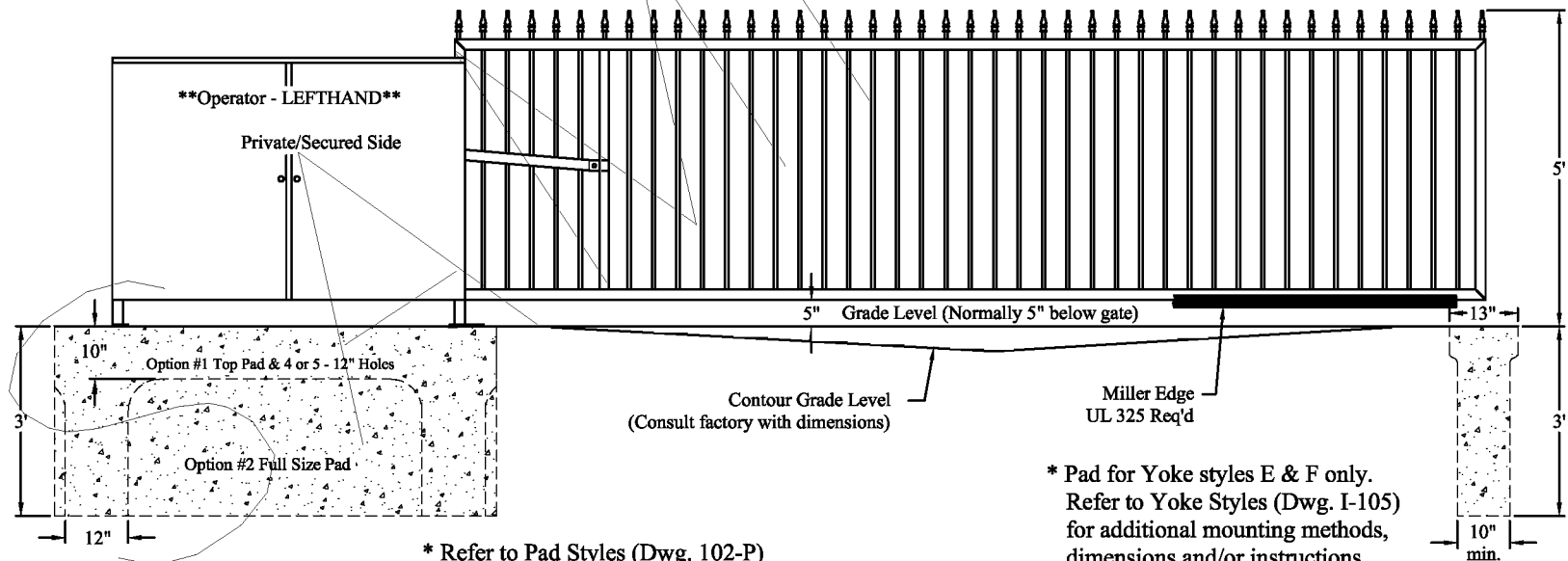



* Refer to Pad Styles (Dwg. 102-P)
for Operator Pad options, notes,
dimensions and/or instructions.

* Pad for Yoke styles E & F only.
Refer to Yoke Styles (Dwg. I-105)
for additional mounting methods,
dimensions and/or instructions.

Date: 12/21/05	AG AutoGate Gate Entry Systems Berlin Heights, Ohio FAX (419) 588-3514
Drn. By: MKS	
Supercedes: 10/26/05	
Dwg.: 101-L	
Title: Std. Layout Dimensions (Sample: 16' x 5')	

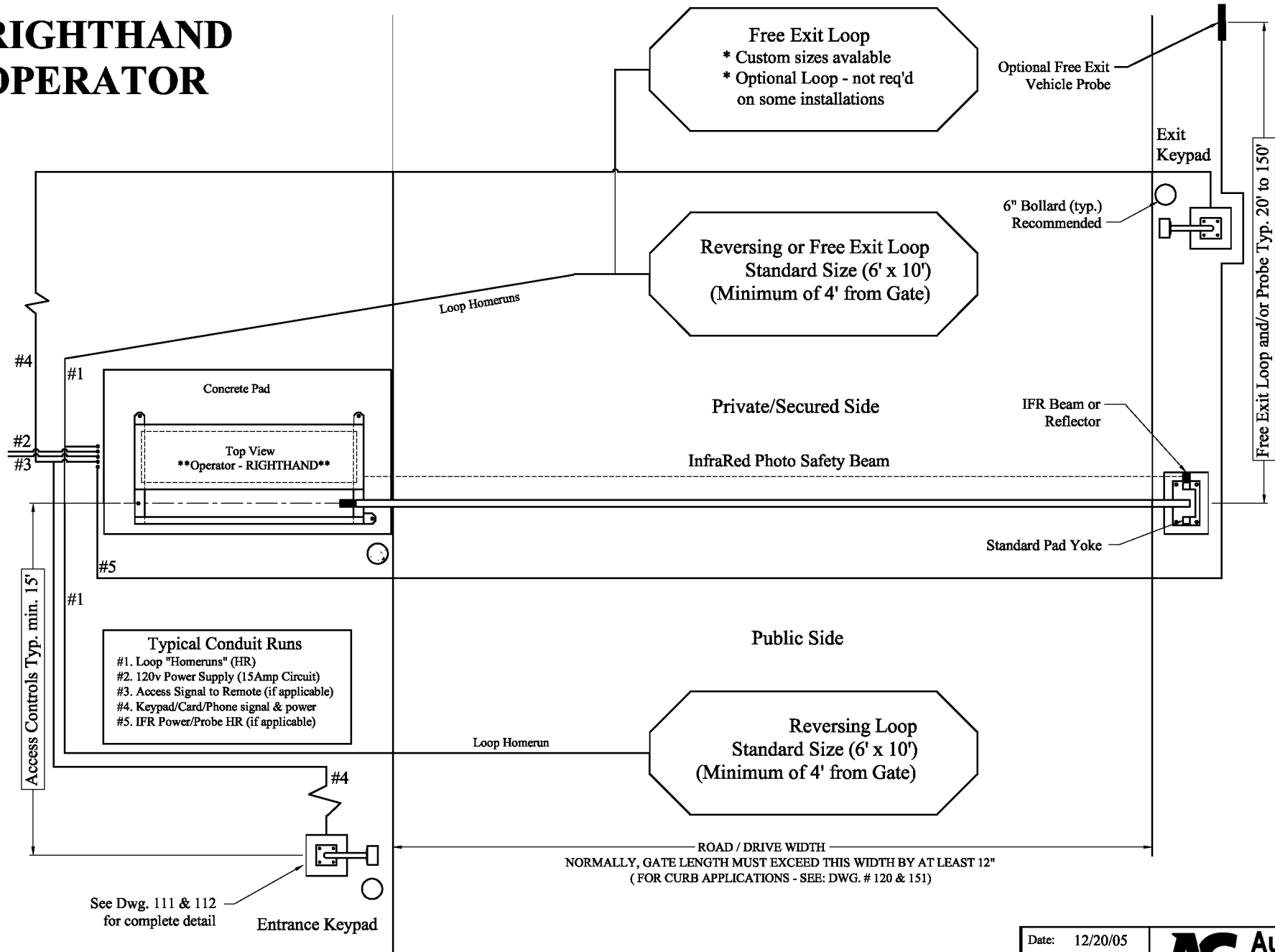
RIGHTHAND OPERATOR



Date: 12/20/05	
Dwn. By: MKS	
Superceded: 7/9/04	
Dwg.: 100-R	
Title: Operator and Accessory Site Layout	

RIGHTHAND OPERATOR

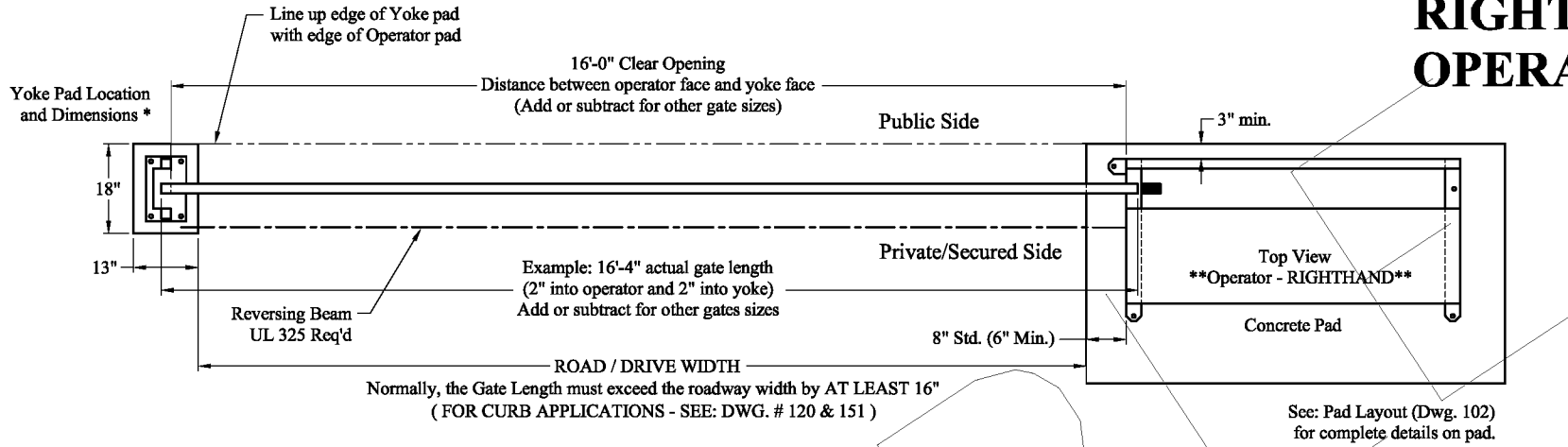

Example Shown: 16' x 5' Buckeye Style 500 Gate

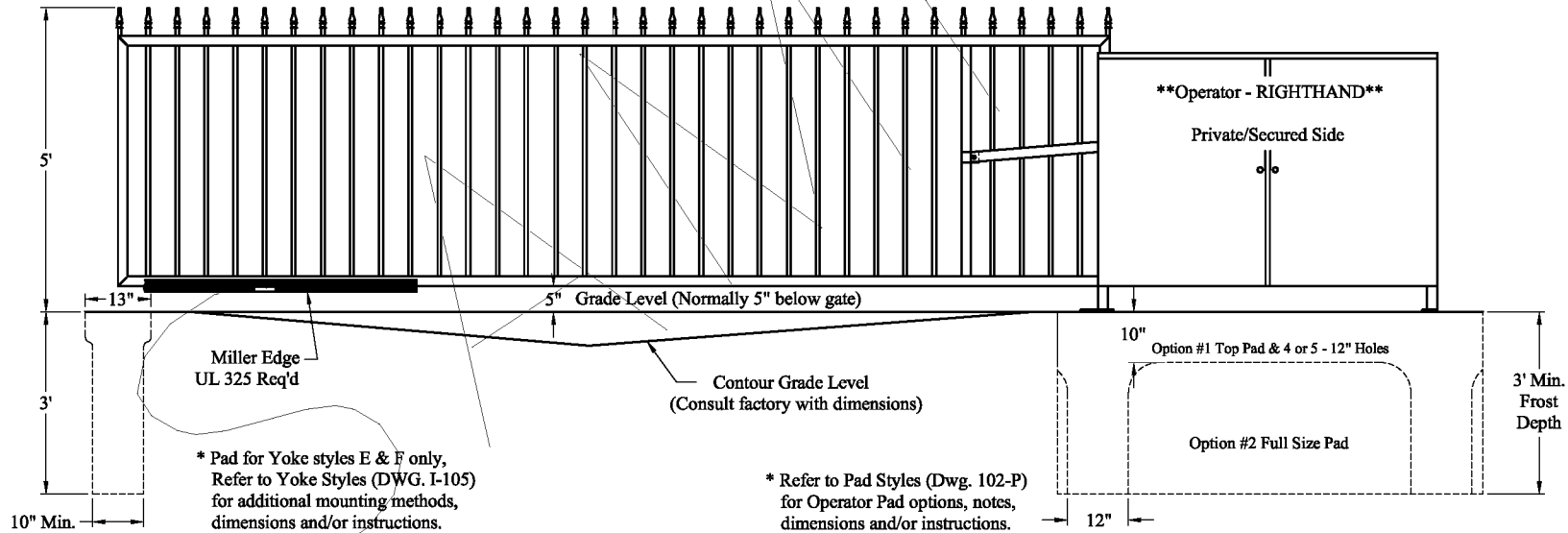

- *All pad depths should be BELOW local frost line
- *Add rebar where applicable
- *Min 3' pad depth or oversized pad in sand or (4) 12" Sonet Tube columns

Date: 12/21/05	AG AutoGate Gate Entry Systems
Drn. By: MKS	
Supersedes: 10/26/05	Berlin Heights, Ohio FAX (419) 588-3514
Dwg.: 101-R	
Title: Std. Layout Dimensions (Sample: 16' x 5')	

Public Side

RIGHTHAND OPERATOR

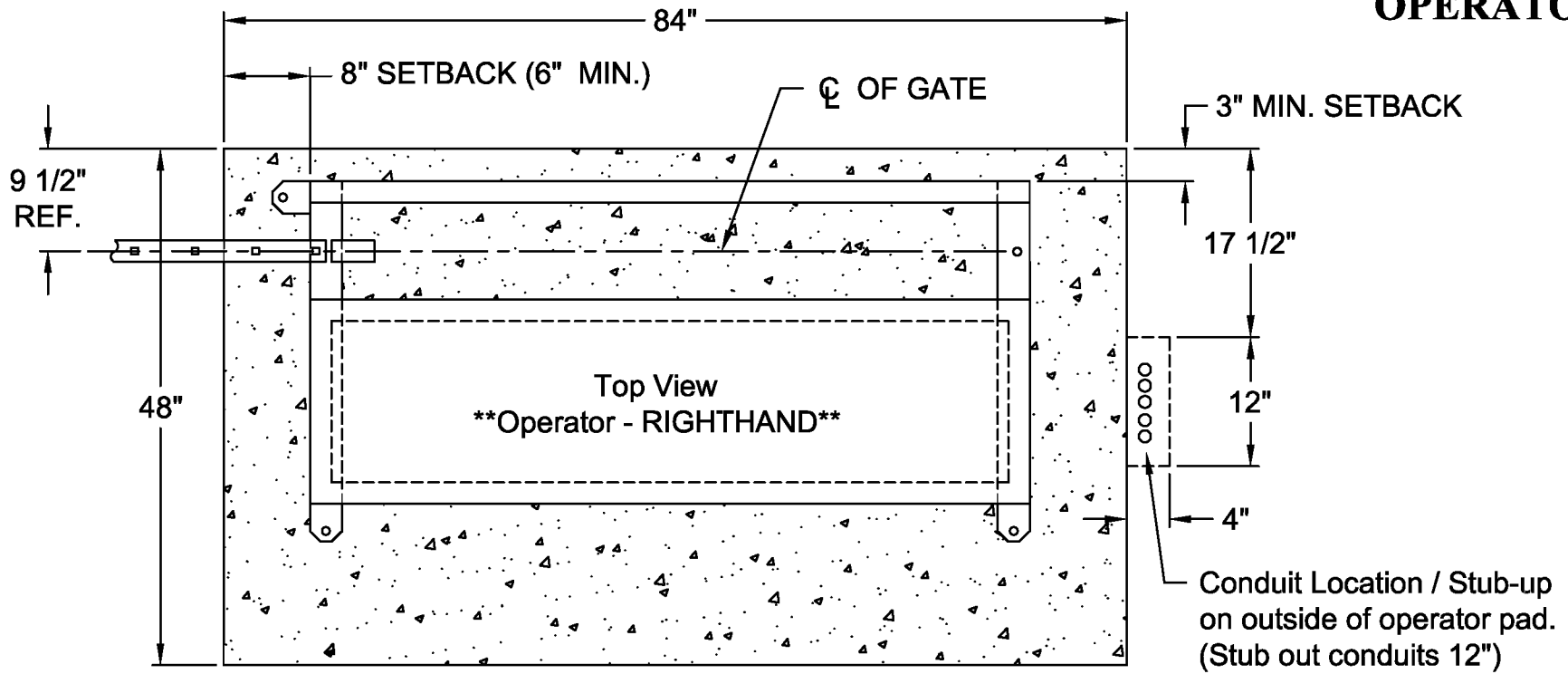

Private/Secured Side

* Note: Use 3/4" Conduit Only

Possible Conduits:

- * 120 vac, min. 15 amp circuit
- * "Entrance" Keypad
- * "Exit" Keypad
- * Reversing/Safety Loops
- * Free Exit Loop
- * Office Communication
- * IFR Beam Power
- * Optional Spares

DO NOT SCALE

Rev.:	Description:	Date:
A	Conduit locations were moved outside the pad	07/18/08 MS

NOTICE
 THE INFORMATION CONTAINED ON THIS DOCUMENT IS CONFIDENTIAL. ANY DISSEMINATION, UNAPPROVED DISCLOSURE OR COPYING OF THIS INFORMATION IS STRICTLY PROHIBITED.
 UNLESS OTHERWISE SPECIFIED DIMENSIONS ARE IN INCHES
 ANGLES ± 1°
 XX ± 1/32, .XX ± .01, .XXX ± .005

Date: 12/07/05
 Dm. By: MKS
 Supersedes: 8/10/05
 Dwg.: 102C-R
 Title: Righthand Conduit Pad Location



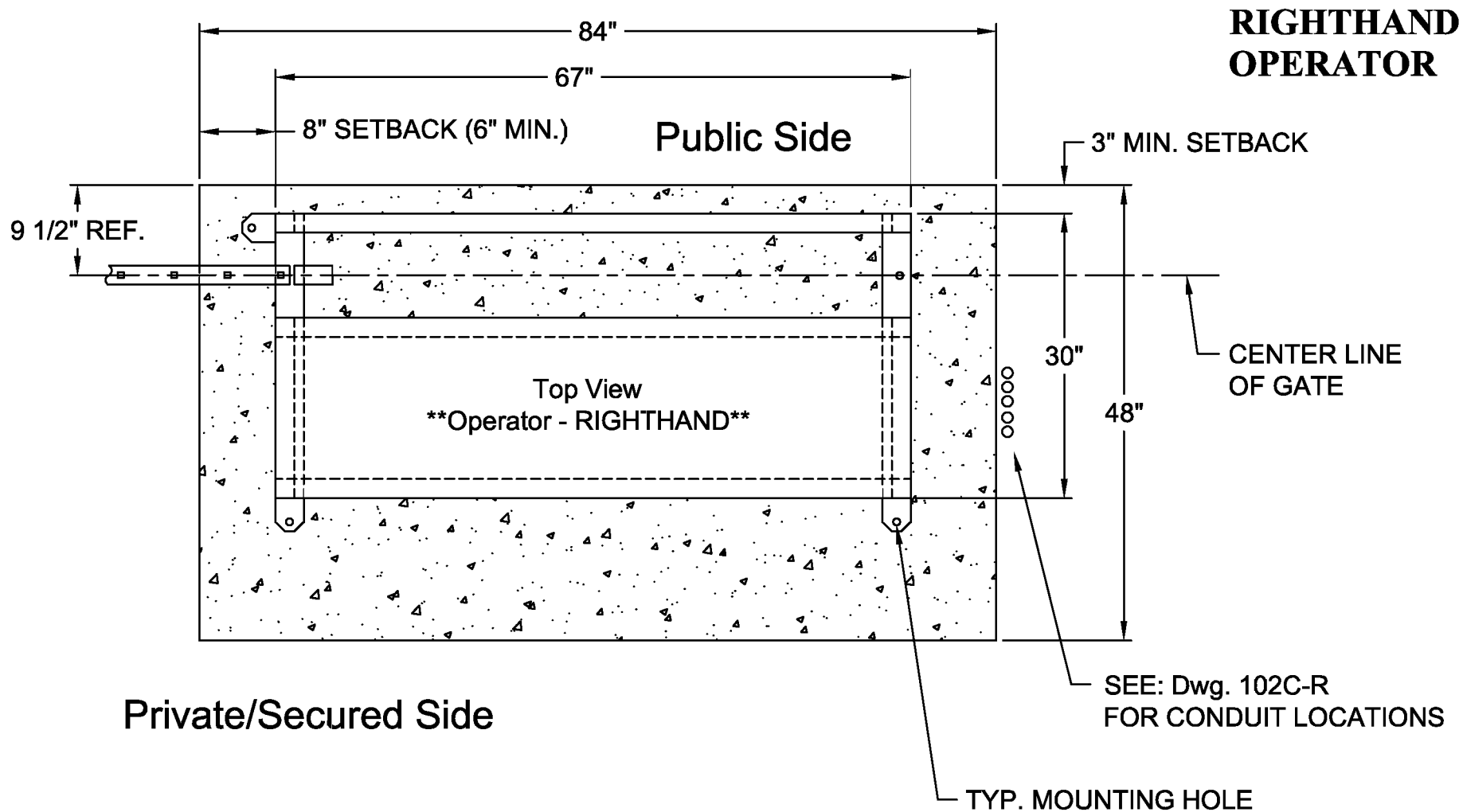

- Notes:
- * Pad dimensions can vary per site
 - * Leave at least 3" between anchor and edge of pad
 - * All Pads should be poured level and below local frost depth
 - * Stub conduits under operator when possible

DO NOT SCALE			NOTICE		Date: 12/07/05	AG AutoGate Gate Entry Systems
			THE INFORMATION CONTAINED ON THIS DOCUMENT IS CONFIDENTIAL. ANY DISSEMINATION, UNAPPROVED DISCLOSURE OR COPYING OF THIS INFORMATION IS STRICTLY PROHIBITED		Drn. By: MKS	
Rev.:	Description:	Date:	UNLESS OTHERWISE SPECIFIED DIMENSIONS ARE IN INCHES ANGLES ± 1° X/X ± 1/32, XX ± .01, XXX ± .005		Supercedes: 8/10/05	Berlin Heights, Ohio FAX (419) 588-3514
A	Conduit locations were moved outside the pad	07/18/08 MS			Dwg.: 102-R	
			Title: Righthand Standard Pad Layout			

LEFTHAND OPERATOR

Public Side

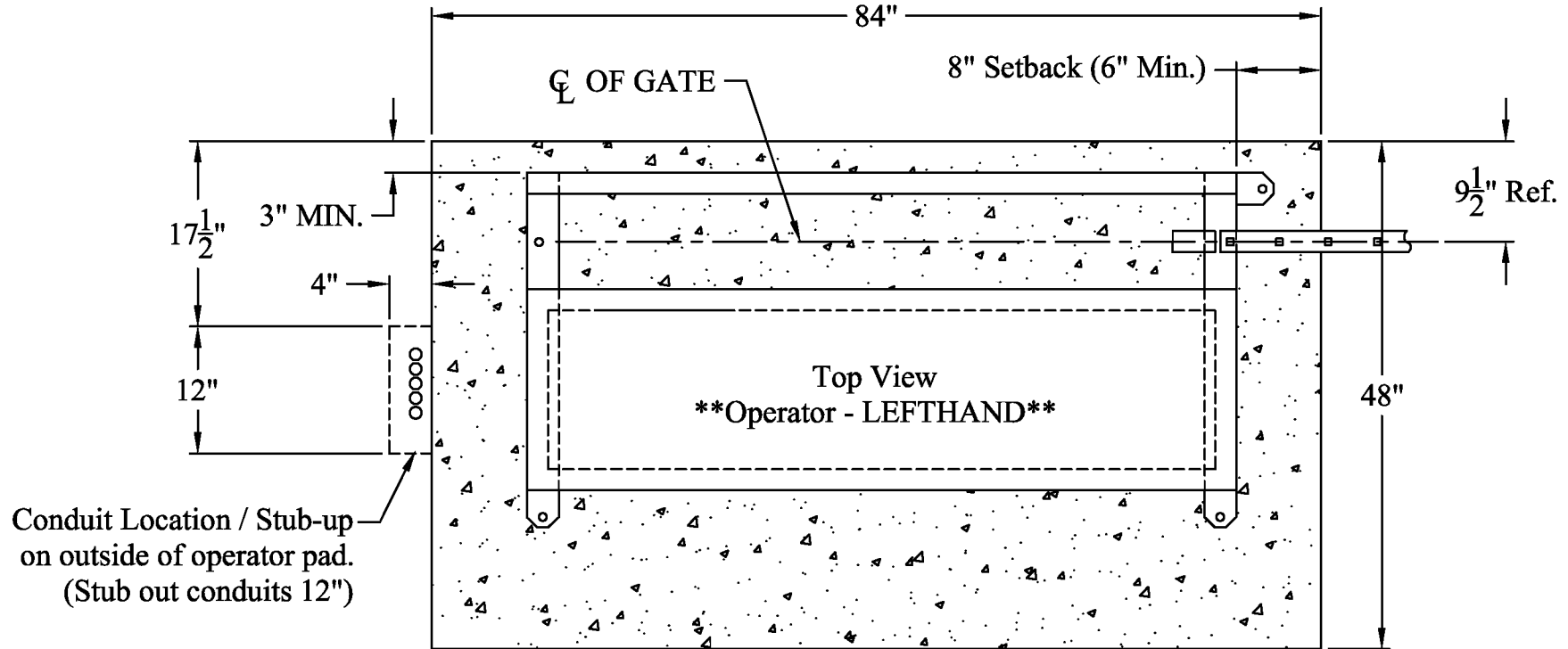

* Note: Use 3/4" Conduit Only

Private/Secured Side

Possible Conduits:

- * 120 vac, min. 15 amp circuit
- * "Entrance" Keypad
- * "Exit" Keypad
- * Reversing/Safety Loops
- * Free Exit Loop
- * Office Communication
- * IFR Beam Power
- * Optional Spares

DO NOT SCALE

Rev.:	Description:	Date:
A	Conduit locations were moved outside the pad	07/18/08 MS

<p align="center">NOTICE</p> <p>THE INFORMATION CONTAINED ON THIS DOCUMENT IS CONFIDENTIAL. ANY DISSEMINATION, UNAPPROVED DISCLOSURE OR COPYING OF THIS INFORMATION IS STRICTLY PROHIBITED</p> <p>UNLESS OTHERWISE SPECIFIED DIMENSIONS ARE IN INCHES ANGLES ± 1° X/X ± 1/32, XX ± .01, XXX ± .005</p>	Date: 12/07/05	 <p>Berlin Heights, Ohio FAX (419) 588-3514</p>
	Drn. By: MKS	
	Supercedes: 8/10/05	Dwg.: 102C-L
	Title: Lefthand Conduit Pad Location	

LEFTHAND OPERATOR

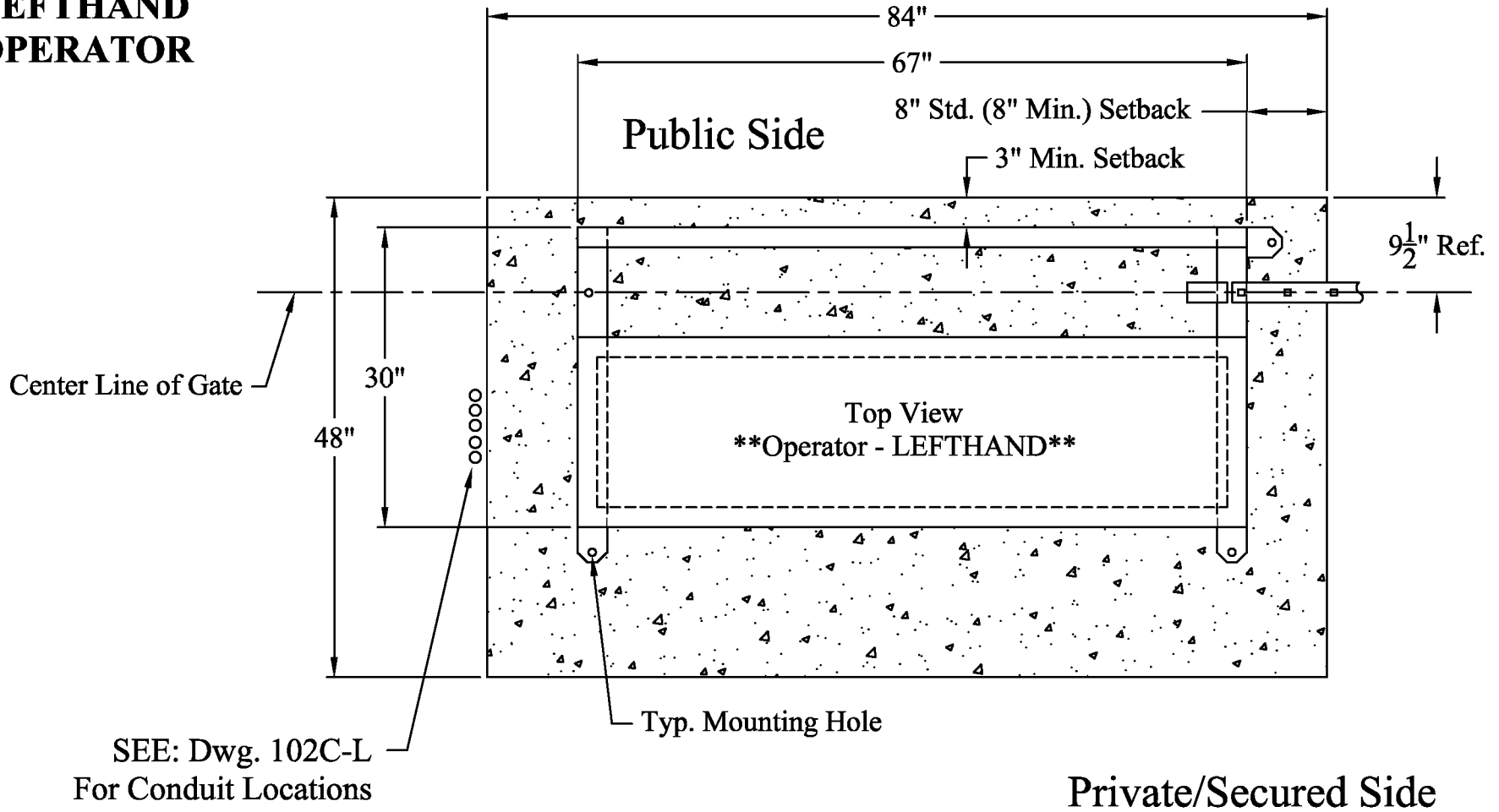

- Notes:
- * Pad dimensions can vary per site
 - * Leave at least 3" between anchor and edge of pad
 - * All Pads should be poured level and below local frost line depth
 - * Stub conduits under operator when possible

DO NOT SCALE		
Rev.:	Description:	Date:
A	Conduit locations were moved outside the pad	07/18/08 MS

<p>NOTICE</p> <p>THE INFORMATION CONTAINED ON THIS DOCUMENT IS CONFIDENTIAL. ANY DISSEMINATION, UNAPPROVED DISCLOSURE OR COPYING OF THIS INFORMATION IS STRICTLY PROHIBITED</p> <p>UNLESS OTHERWISE SPECIFIED DIMENSIONS ARE IN INCHES ANGLES ± 1°</p> <p>X/X ± 1/32, XX ± .01, XXX ± .005</p>	Date: 12/07/05	 <p>Berlin Heights, Ohio FAX (419) 588-3514</p>
	Dwn. By: MKS	
	Supercedes: 8/10/05	Dwg.: 102-L
	Title: Lefthand Standard Pad Layout	

OPTION #1:

(4) or (5) MIN. 12" AUGURED HOLES, RE-BAR, AND AN 8" TO 10" TOP PAD

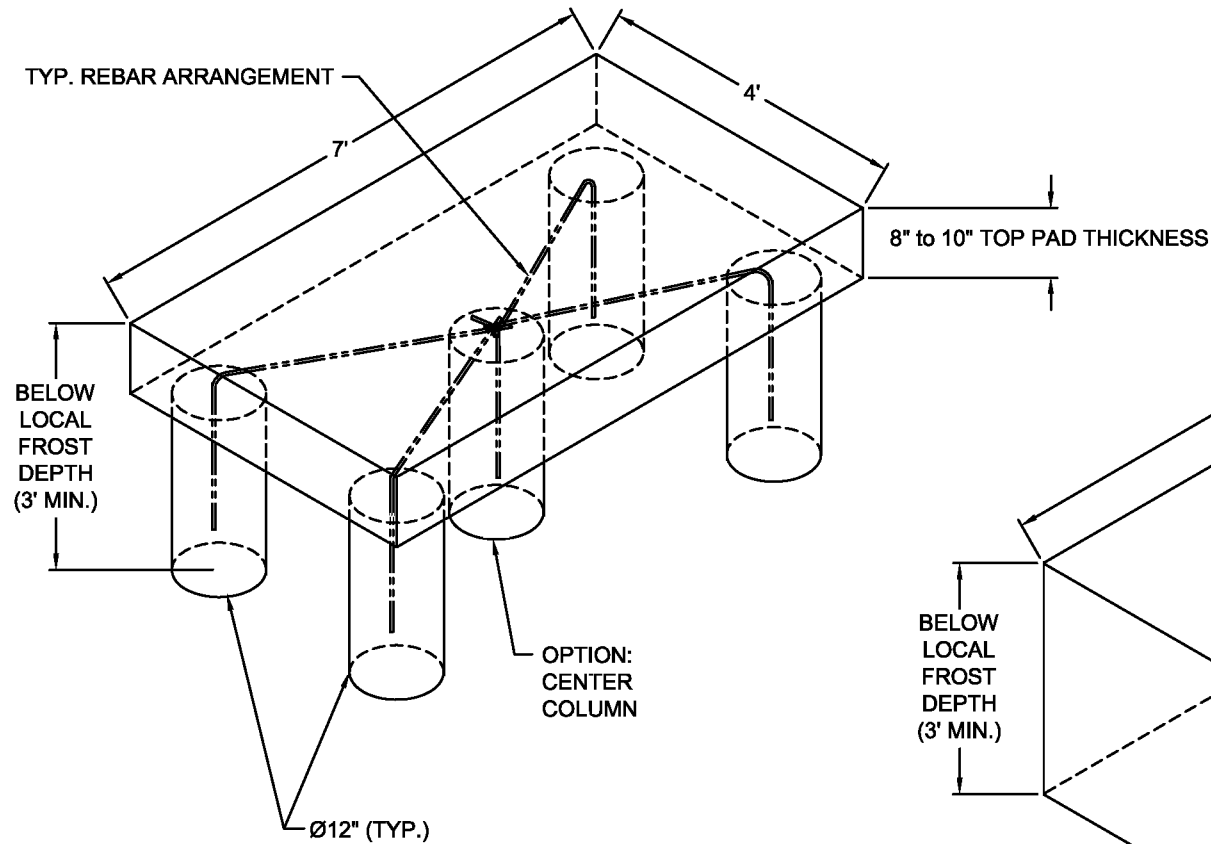

8" to 10" TOP PAD THICKNESS

BELOW
LOCAL
FROST
DEPTH
(3' MIN.)

OPTION:
CENTER
COLUMN

$\text{Ø}12"$ (TYP.)

BELOW
LOCAL
FROST
DEPTH
(3' MIN.)

OPTION #2:

FULL CONCRETE PAD WITH RE-BAR WHERE APPLICABLE

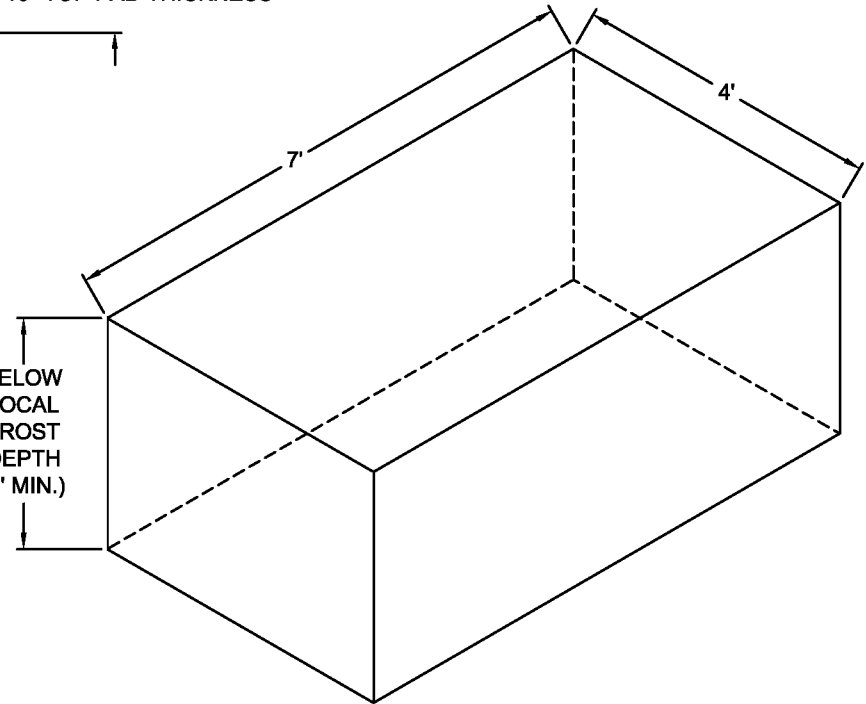

NOTES:

- * ALL PAD DEPTHS SHOULD BE BELOW LOCAL FROST DEPTH
- * TOP OF PAD SHOULD BE FLAT AND LEVEL

Date: 12/21/05

Drn. By: MKS

Supersedes: 7/12/04

Dwg.: 102-P

Title: Operator PAD Layout / Options



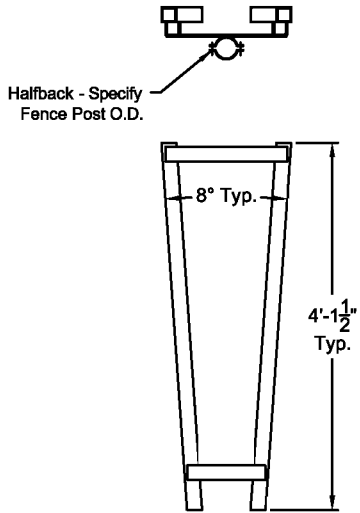

Grade
STYLE 'A'
Post Mounted

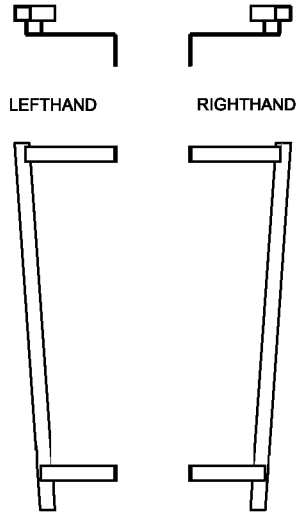

STYLE 'C'
Offset Wall or Post Mounted

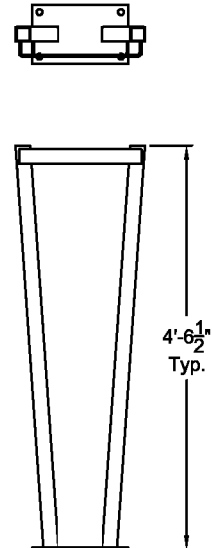

STYLE 'E'
Standard Pad Mounted

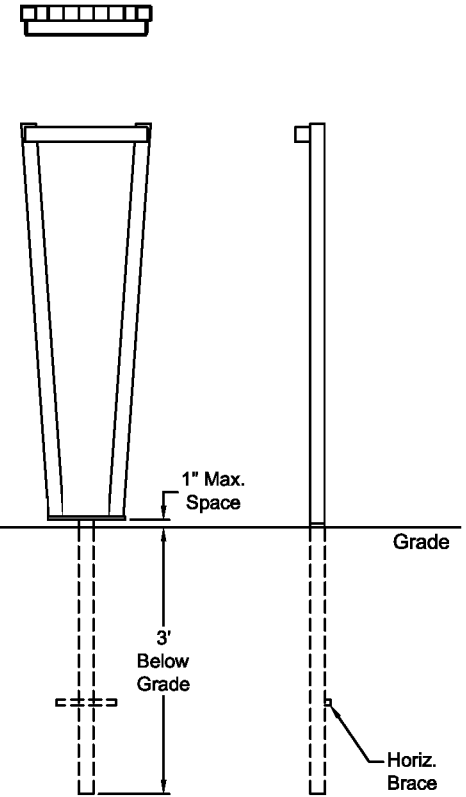

STYLE 'G'
Buried in Ground

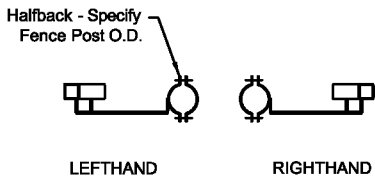

LEFTHAND RIGHTHAND

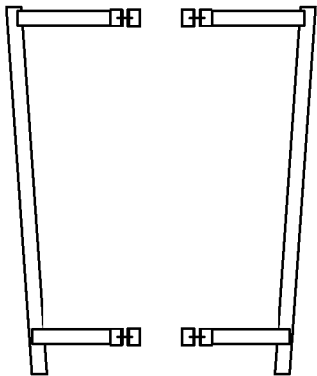

Grade
STYLE 'B'
Post Mounted

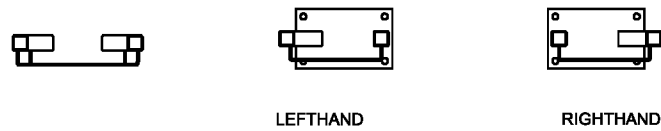

LEFTHAND RIGHTHAND

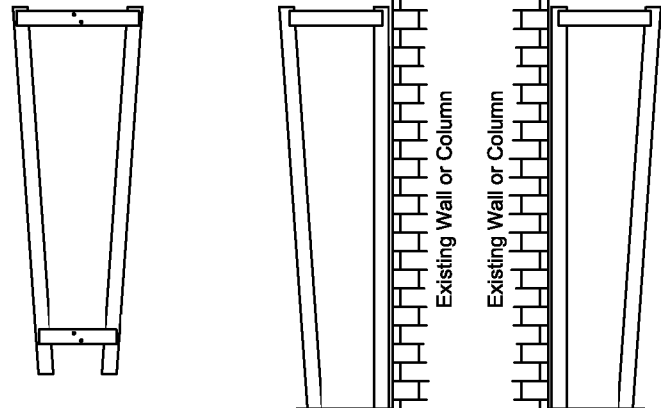

Grade
STYLE 'D'
Wall or Post Mounted
STYLE 'F'
Gate Perpendicular to Wall

NOTES:

- 1) All of these standard yokes are 5' tall.
- 2) Style 'G' protrudes an additional 36" in the ground.
- 3) Styles 'A' through 'D' is mounted 5" above grade.
- 4) Unless specified, gate is furnished with Style 'E'.

Date:	12/21/05		AutoGate
Dm. By:	MKS		Gate Entry Systems
Supercedes:	7/8/04		Berlin Heights, Ohio FAX (419) 588-3514
Dwg.:	105		
Title:	YOKE STYLES (5' STANDARD)		